

Data Sheet



Article number: 03508090

Description: Fluro Rod end GE 90FW-2RS

Measures

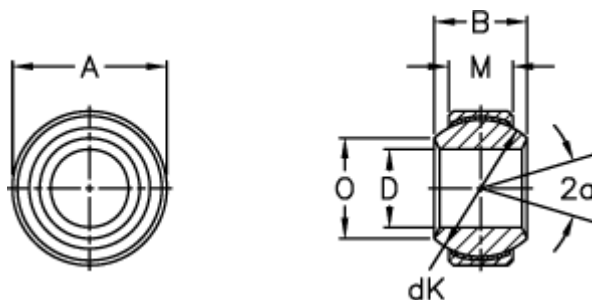

A = 150 0 -0,018

B = 85

D = 90 0 -0,020

dK = 130

Dynamic load C (kN) = 1145

M = 55

O = 98.3

Static load C0 (kN) = 2290

Tilt angle = 15

Weight = 5300